



- ★ 100% EAS Guaranteed
- ★ Green Device Available
- ★ Super Low Gate Charge
- ★ Excellent CdV/dt effect decline
- ★ Advanced high cell density Trench technology

Product Summary

BVDSS	RDSON	ID
20V	2.7mΩ	90A

Description

The XXW90N02F is the high cell density trenched N-ch MOSFETs, which provide excellent RDSON and gate charge for most of the synchronous buck converter applications. The XXW90N02F meet the RoHS and Green Product requirement, 100% EAS guaranteed with full function reliability approved.

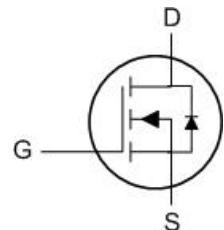
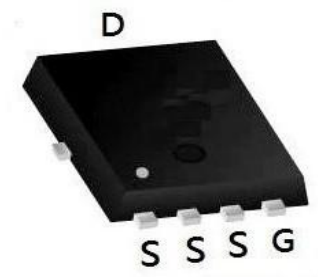
PDFN5060-8L Pin Configuration

Absolute Maximum Ratings

Symbol	Parameter	Rating	Units
V_{DS}	Drain-Source Voltage	20	V
V_{GS}	Gate-Source Voltage	± 20	V
$I_D@T_C=25^\circ C$	Continuous Drain Current, $V_{GS} @ 10V^1$	90	A
$I_D@T_C=100^\circ C$	Continuous Drain Current, $V_{GS} @ 10V^1$	59	A
I_{DM}	Pulsed Drain Current ²	360	A
EAS	Single Pulse Avalanche Energy ³	118	mJ
I_{AS}	Avalanche Current	41	A
$P_D@T_C=25^\circ C$	Total Power Dissipation ⁴	88	W
T_{STG}	Storage Temperature Range	-55 to 150	$^\circ C$
T_J	Operating Junction Temperature Range	-55 to 150	$^\circ C$

Thermal Data

Symbol	Parameter	Typ.	Max.	Unit
$R_{\theta JC}$	Thermal Resistance Junction-Case ¹	---	1.8	$^\circ C/W$

Electrical Characteristics ($T_J=25^\circ\text{C}$ unless otherwise specified)

Symbol	Parameter	Test Condition	Min.	Typ.	Max.	Units
Off Characteristic						
$V_{(BR)DSS}$	Drain-Source Breakdown Voltage	$V_{GS}=0V, I_D=250\mu A$	20	-	-	V
I_{DSS}	Zero Gate Voltage Drain Current	$V_{DS}=20V, V_{GS}=0V$	-	-	1	μA
I_{GSS}	Gate to Body Leakage Current	$V_{GS}=\pm 12V, V_{DS}=0V$	-	-	± 100	nA
On Characteristics						
$V_{GS(th)}$	Gate Threshold Voltage	$V_{DS}=V_{GS}, I_D=250\mu A$	0.4	0.7	1.0	V
$R_{DS(on)}$	Static Drain-Source On-Resistance <small>note3</small>	$V_{GS}=4.5V, I_D=30A$	-	2.7	3.5	m Ω
		$V_{GS}=2.5V, I_D=20A$	-	4	5.2	
Dynamic Characteristics						
C_{iss}	Input Capacitance	$V_{DS}=10V, V_{GS}=0V,$ $f=1.0MHz$	-	3200	-	pF
C_{oss}	Output Capacitance		-	460	-	pF
C_{rss}	Reverse Transfer Capacitance		-	445	-	pF
Q_g	Total Gate Charge	$V_{DS}=10V, I_D=30A,$ $V_{GS}=4.5V$	-	48	-	nC
Q_{gs}	Gate-Source Charge		-	3.6	-	nC
Q_{gd}	Gate-Drain("Miller") Charge		-	19	-	nC
Switching Characteristics						
$t_{d(on)}$	Turn-On Delay Time	$V_{DS}=10V, I_D=30A,$ $R_G=1.8\Omega, V_{GS}=4.5V$	-	9.7	-	ns
t_r	Turn-On Rise Time		-	37	-	ns
$t_{d(off)}$	Turn-Off Delay Time		-	63	-	ns
t_f	Turn-Off Fall Time		-	52	-	ns
Drain-Source Diode Characteristics and Maximum Ratings						
I_S	Maximum Continuous Drain to Source Diode Forward Current		-	-	90	A
I_{SM}	Maximum Pulsed Drain to Source Diode Forward Current		-	-	360	A
V_{SD}	Drain to Source Diode Forward Voltage	$V_{GS}=0V, I_{SD}=30A,$ $T_J=25^\circ\text{C}$	-	-	1.2	V
t_{rr}	Reverse Recovery Time	$T_J=25^\circ\text{C}, I_F=30A,$ $di/dt=100A/\mu s$	-	23	-	ns
Q_{rr}	Reverse Recovery Charge		-	10	-	nC

Notes:1. Repetitive Rating: Pulse Width Limited by Maximum Junction Temperature

2. EAS condition: $T_J=25^\circ\text{C}, V_{DD}=15V, V_G=4.5V, R_G=25\Omega, L=0.5mH, I_{AS}=21A$

3. Pulse Test: Pulse Width $\leq 300\mu s$, Duty Cycle $\leq 0.5\%$

Typical Performance Characteristics

Figure 1: Output Characteristics

Figure 2: Typical Transfer Characteristics

Figure 3: On-resistance vs. Drain Current

Figure 4: Body Diode Characteristics

Figure 5: Gate Charge Characteristics

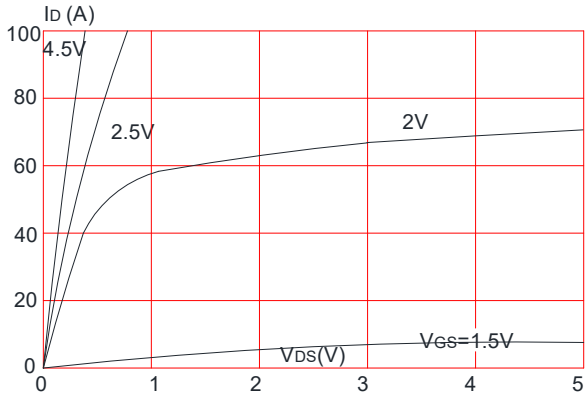
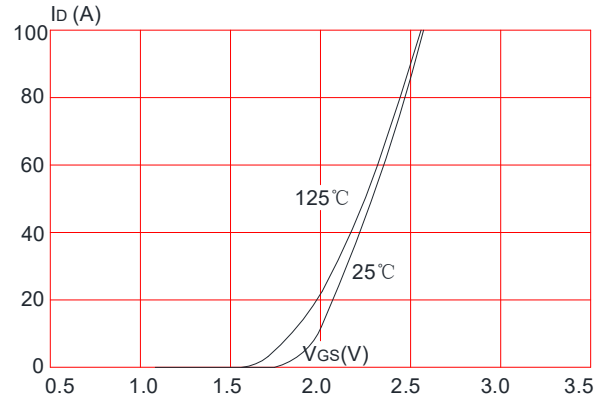
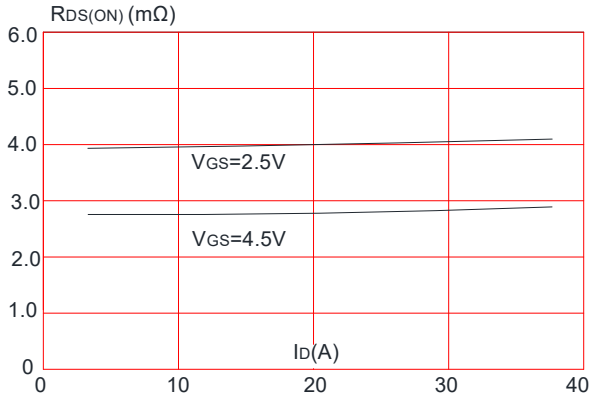
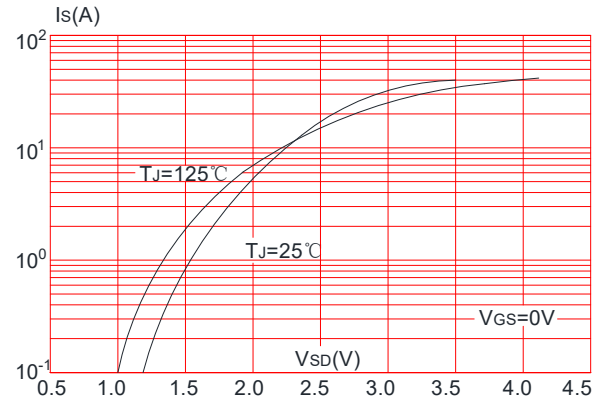
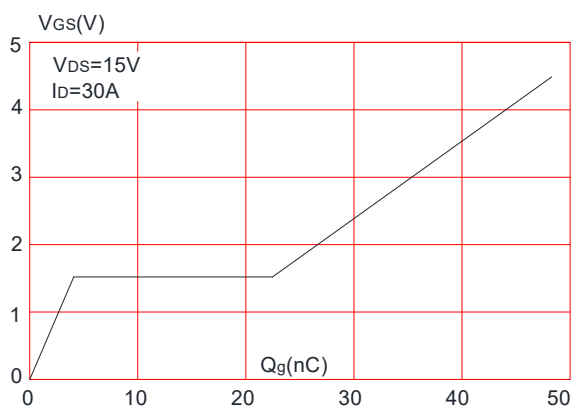
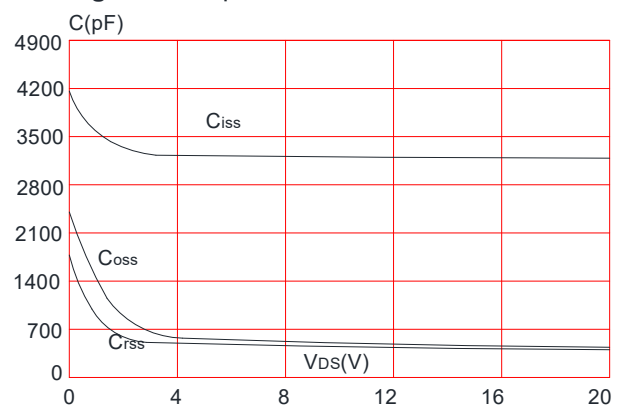
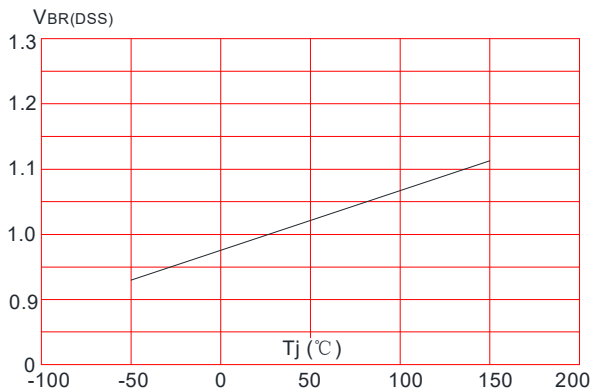
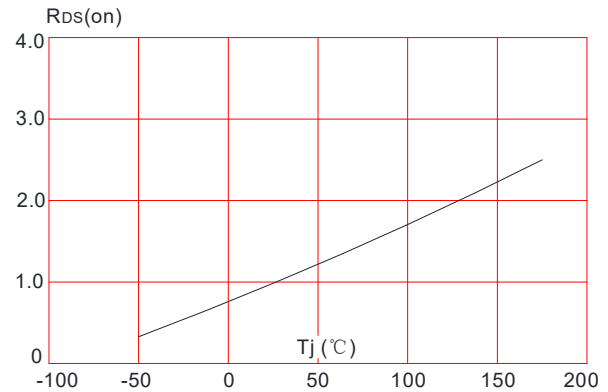
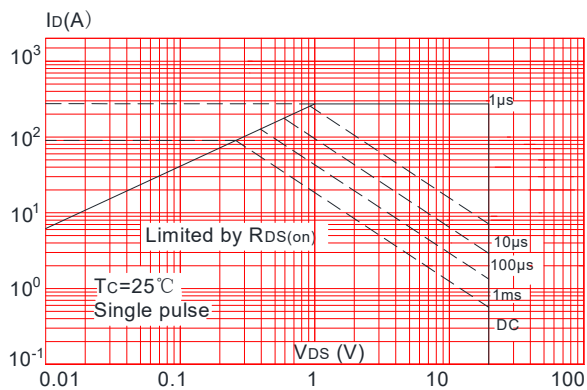
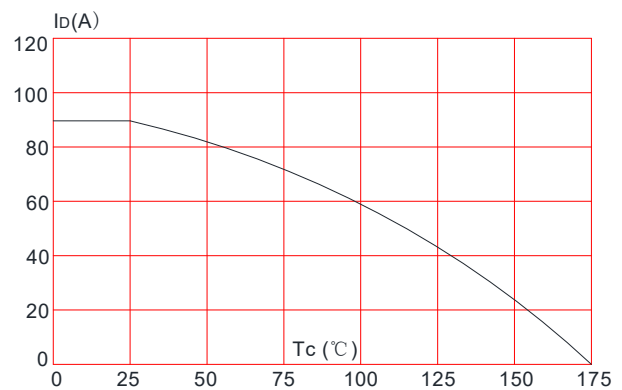
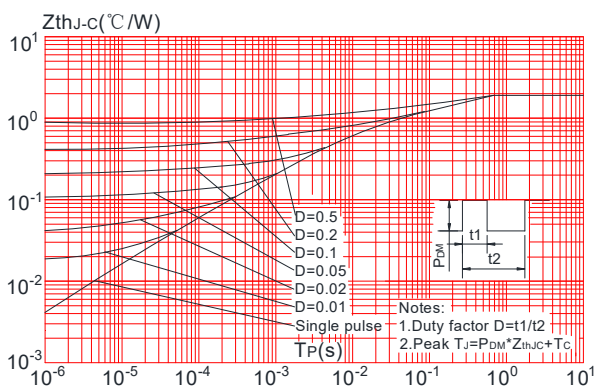
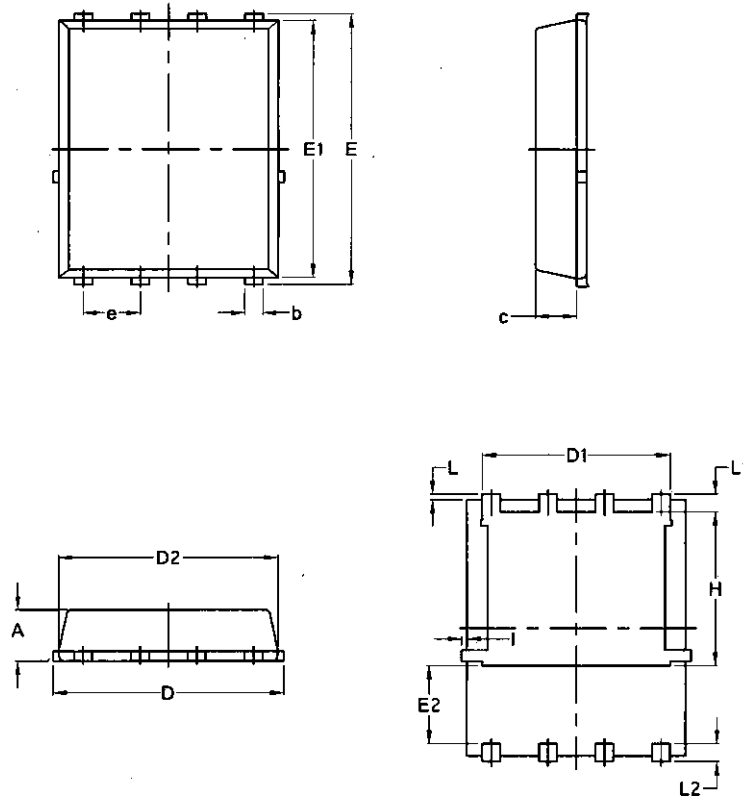
Figure 6: Capacitance Characteristics

Figure 7: Normalized Breakdown Voltage vs. Junction Temperature

Figure 8: Normalized on Resistance vs. Junction Temperature

Figure 9: Maximum Safe Operating Area

Figure 10: Maximum Continuous Drain Current vs. Case Temperature

Figure.11: Maximum Effective Transient Thermal Impedance, Junction-to-Case

Package Mechanical Data-PDFN5060-8L-Single

Symbol	Common			
	mm		Inch	
	Min	Max	Min	Max
A	1.03	1.17	0.0406	0.0461
b	0.34	0.48	0.0134	0.0189
c	0.824	0.0970	0.0324	0.082
D	4.80	5.40	0.1890	0.2126
D1	4.11	4.31	0.1618	0.1697
D2	4.80	5.00	0.1890	0.1969
E	5.95	6.15	0.2343	0.2421
E1	5.65	5.85	0.2224	0.2303
E2	1.60	/	0.0630	/
e	1.27 BSC		0.05 BSC	
L	0.05	0.25	0.0020	0.0098
L1	0.38	0.50	0.0150	0.0197
L2	0.38	0.50	0.0150	0.0197
H	3.30	3.50	0.1299	0.1378
I	/	0.18	/	0.0070