



- ★ 100% EAS Guaranteed
- ★ Green Device Available
- ★ Super Low Gate Charge
- ★ Excellent CdV/dt effect decline
- ★ Advanced high cell density Trench technology

**Product Summary**

BVDSS	RDS(on)	ID
20V	4.8 mΩ	60A

**Description**

The XXW60N02 is the high cell density trenched N-ch MOSFETs, which provide excellent RDS(on) and gate charge for most of the synchronous buck converter applications.

The XXW60N02 meet the RoHS and Green Product requirement, 100% EAS guaranteed with full function reliability approved.

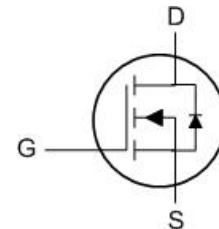
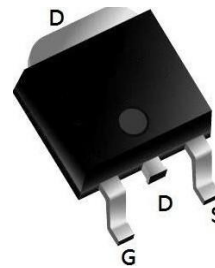
**TO252 Pin Configuration**

**Absolute Maximum Ratings**

Symbol	Parameter	Rating	Units
$V_{DS}$	Drain-Source Voltage	20	V
$V_{GS}$	Gate-Source Voltage	$\pm 20$	V
$I_D@T_C=25^\circ C$	Continuous Drain Current, $V_{GS} @ 10V^1$	60	A
$I_D@T_C=100^\circ C$	Continuous Drain Current, $V_{GS} @ 10V^1$	35	A
$I_{DM}$	Pulsed Drain Current <sup>2</sup>	240	A
EAS	Single Pulse Avalanche Energy <sup>3</sup>	48	mJ
$I_{AS}$	Avalanche Current	31	A
$P_D@T_C=25^\circ C$	Total Power Dissipation <sup>4</sup>	38	W
$T_{STG}$	Storage Temperature Range	-55 to 150	$^\circ C$
$T_J$	Operating Junction Temperature Range	-55 to 150	$^\circ C$

**Thermal Data**

Symbol	Parameter	Typ.	Max.	Unit
$R_{\theta JC}$	Thermal Resistance Junction-Case <sup>1</sup>	---	4.2	$^\circ C/W$

**Electrical Characteristics** ( $T_J=25^{\circ}\text{C}$  unless otherwise specified)

Symbol	Parameter	Test Condition	Min.	Typ.	Max.	Units
<b>Off Characteristic</b>						
$V_{(BR)DSS}$	Drain-Source Breakdown Voltage	$V_{GS}=0V, I_D=250\mu A$	20	-	-	V
$I_{DSS}$	Zero Gate Voltage Drain Current	$V_{DS}=20V, V_{GS}=0V,$	-	-	1.0	$\mu A$
$I_{GSS}$	Gate to Body Leakage Current	$V_{DS}=0V, V_{GS}=\pm 12V$	-	-	$\pm 100$	nA
<b>On Characteristics</b>						
$V_{GS(th)}$	Gate Threshold Voltage	$V_{DS}=V_{GS}, I_D=250\mu A$	0.4	0.7	1.0	V
$R_{DS(on)}$	Static Drain-Source on-Resistance <small>note3</small>	$V_{GS}=4.5V, I_D=25A$	-	4.8	6.5	m $\Omega$
		$V_{GS}=2.5V, I_D=15A$	-	6.8	10	
<b>Dynamic Characteristics</b>						
$C_{iss}$	Input Capacitance	$V_{DS}=10V, V_{GS}=0V,$ $f=1.0MHz$	-	1832	-	pF
$C_{oss}$	Output Capacitance		-	289	-	pF
$C_{rss}$	Reverse Transfer Capacitance		-	271	-	pF
$Q_g$	Total Gate Charge	$V_{DS}=10V, I_D=25A,$ $V_{GS}=4.5V$	-	23	-	nC
$Q_{gs}$	Gate-Source Charge		-	4.5	-	nC
$Q_{gd}$	Gate-Drain("Miller") Charge		-	7.3	-	nC
<b>Switching Characteristics</b>						
$t_{d(on)}$	Turn-on Delay Time	$V_{DS}=10V,$ $I_D=25A, R_{GEN}=3\Omega,$ $V_{GS}=4.5V$	-	15	-	ns
$t_r$	Turn-on Rise Time		-	37	-	ns
$t_{d(off)}$	Turn-off Delay Time		-	52	-	ns
$t_f$	Turn-off Fall Time		-	21	-	ns
<b>Drain-Source Diode Characteristics and Maximum Ratings</b>						
$I_S$	Maximum Continuous Drain to Source Diode Forward Current		-	-	60	A
$I_{SM}$	Maximum Pulsed Drain to Source Diode Forward Current		-	-	240	A
$V_{SD}$	Drain to Source Diode Forward Voltage	$V_{GS}=0V, I_S=30A$	-	-	1.2	V
$t_{rr}$	Body Diode Reverse Recovery Time	$I_F=25A, dI/dt=100A/\mu s$	-	25	-	ns
$Q_{rr}$	Body Diode Reverse Recovery Charge		-	21	-	nC

Notes:1. Repetitive Rating: Pulse Width Limited by Maximum Junction Temperature

 2. EAS condition:  $T_J=25^{\circ}\text{C}$ ,  $V_{DD}=10V$ ,  $V_G=4.5V$ ,  $L=0.5mH$ ,  $R_G=25\Omega$ ,  $I_{AS}=13.8A$ 

 3. Pulse Test: Pulse Width $\leq 300\mu s$ , Duty Cycle $\leq 0.5\%$

## Typical Performance Characteristics

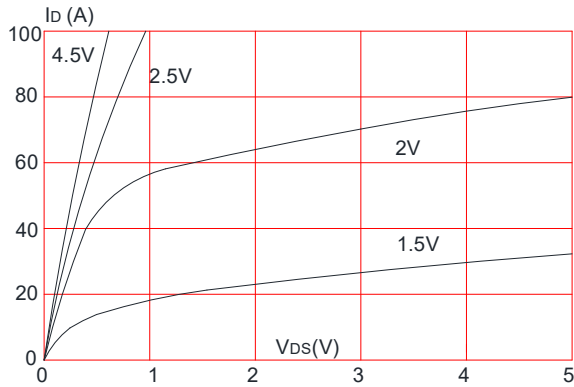
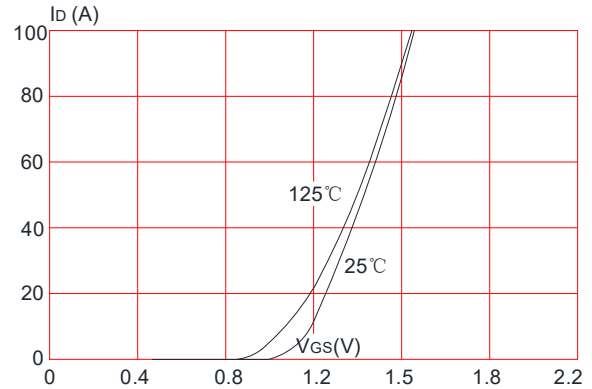
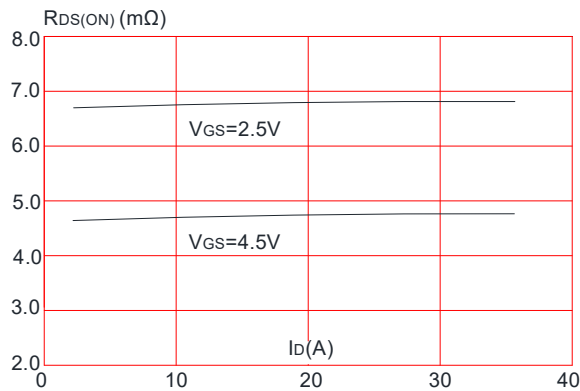
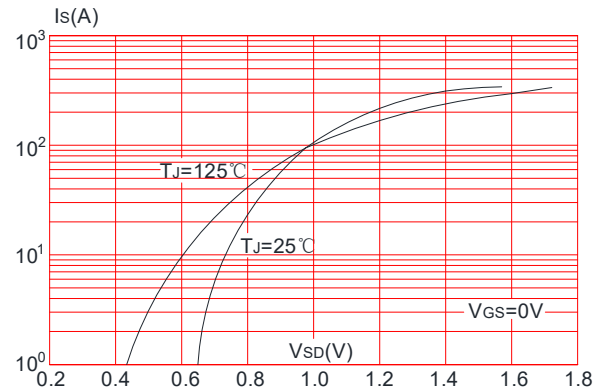
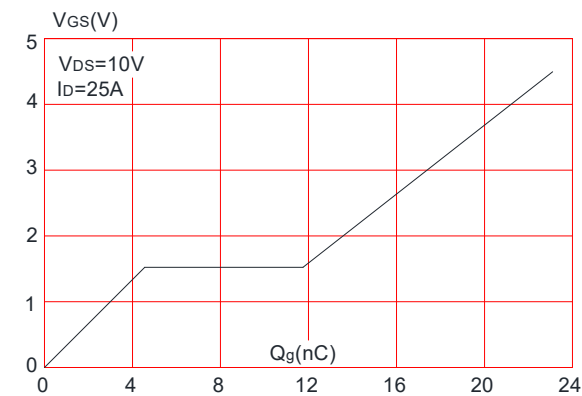
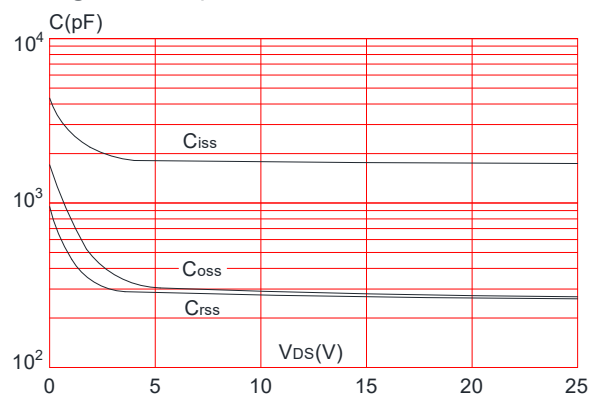
**Figure 1: Output Characteristics**

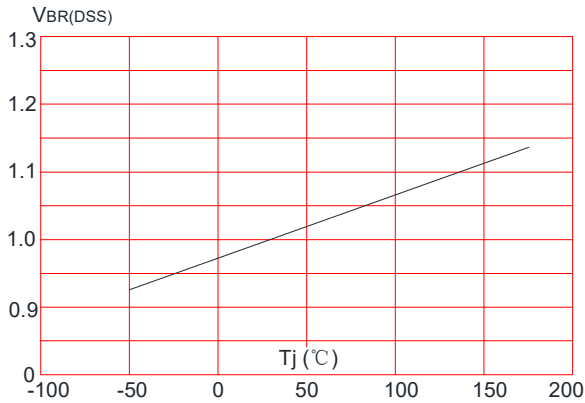
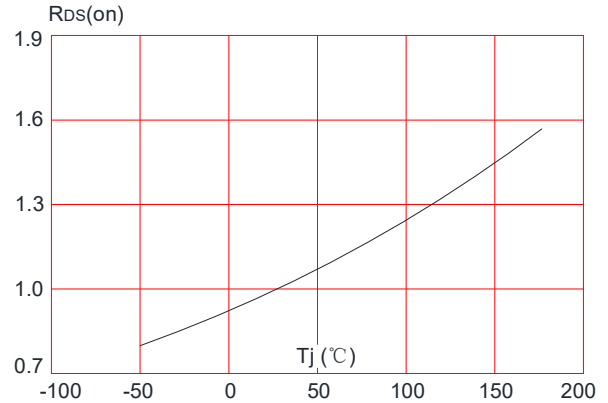
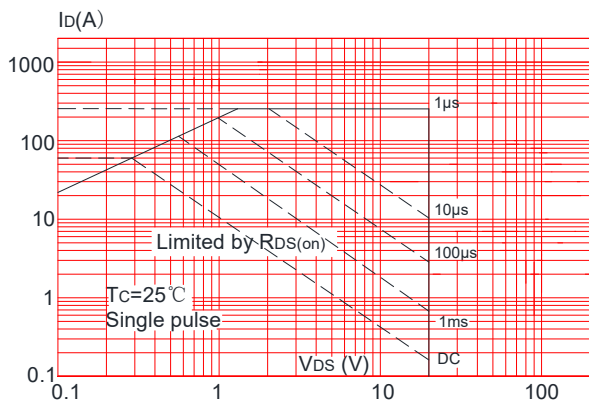
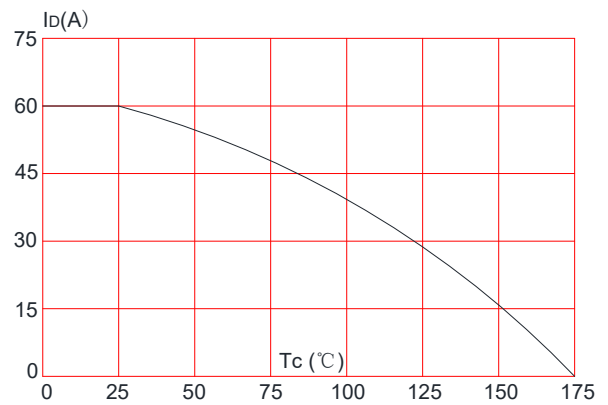
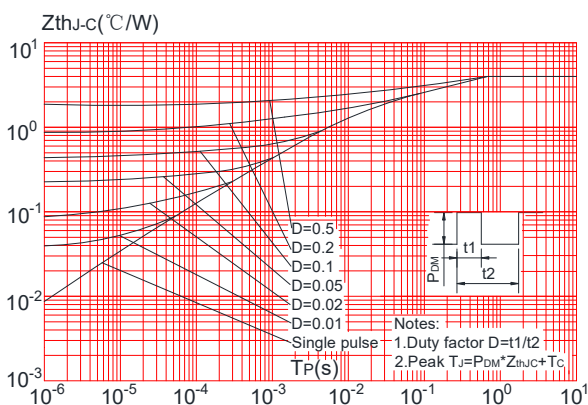
**Figure 2: Typical Transfer Characteristics**

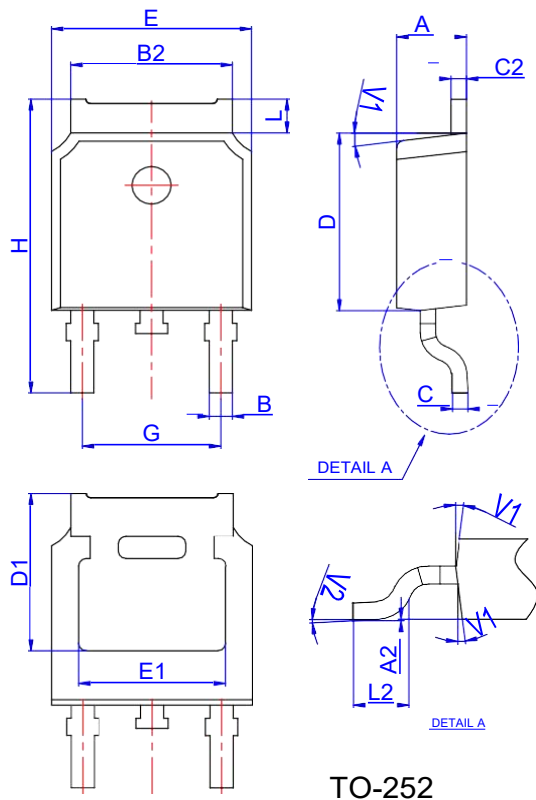
**Figure 3: On-resistance vs. Drain Current**

**Figure 4: Body Diode Characteristics**

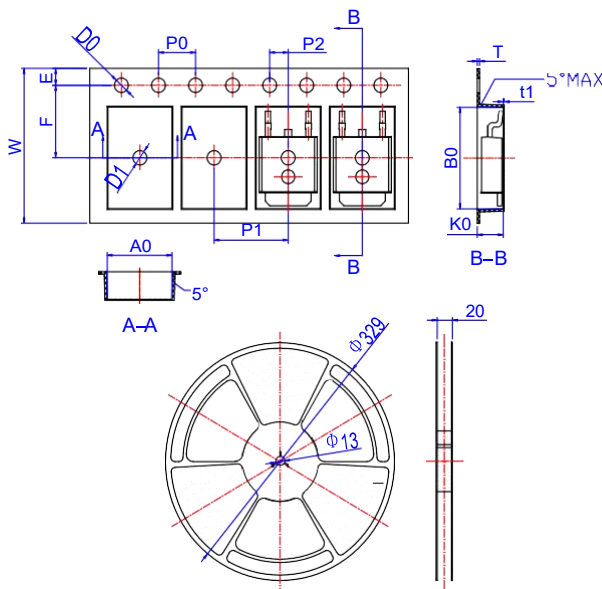
**Figure 5: Gate Charge Characteristics**

**Figure 6: Capacitance Characteristics**

**Figure 7: Normalized Breakdown Voltage vs. Junction Temperature**

**Figure 8: Normalized on Resistance vs. Junction Temperature**

**Figure 9: Maximum Safe Operating Area**

**Figure 10: Maximum Continuous Drain Current vs. Case Temperature**

**Figure.11: Maximum Effective Transient Thermal Impedance, Junction-to-Case**

**Package Mechanical Data TO 252**

Ref.	Dimensions					
	Millimeters			Inches		
	Min.	Typ.	Max.	Min.	Typ.	Max.
A	2.10		2.50	0.083		0.098
A2	0		0.10	0		0.004
B	0.66		0.86	0.026		0.034
B2	5.18		5.48	0.202		0.216
C	0.40		0.60	0.016		0.024
C2	0.44		0.58	0.017		0.023
D	5.90		6.30	0.232		0.248
D1	5.30REF			0.209REF		
E	6.40		6.80	0.252		0.268
E1	4.63			0.182		
G	4.47		4.67	0.176		0.184
H	9.50		10.70	0.374		0.421
L	1.09		1.21	0.043		0.048
L2	1.35		1.65	0.053		0.065
V1		7°			7°	
V2	0°		6°	0°		6°

**Reel Specification-TO-252-4R**

Ref.	Dimensions					
	Millimeters			Inches		
	Min.	Typ.	Max.	Min.	Typ.	Max.
W	15.90	16.00	16.10	0.626	0.630	0.634
E	1.65	1.75	1.85	0.065	0.069	0.073
F	7.40	7.50	7.60	0.291	0.295	0.299
D0	1.40	1.50	1.60	0.055	0.059	0.063
D1	1.40	1.50	1.60	0.055	0.059	0.063
P0	3.90	4.00	4.10	0.154	0.157	0.161
P1	7.90	8.00	8.10	0.311	0.315	0.319
P2	1.90	2.00	2.10	0.075	0.079	0.083
A0	6.85	6.90	7.00	0.270	0.271	0.276
B0	10.45	10.50	10.60	0.411	0.413	0.417
K0	2.68	2.78	2.88	0.105	0.109	0.113
T	0.24		0.27	0.009		0.011
t1	0.10			0.004		
10P0	39.80	40.00	40.20	1.567	1.575	1.583