

MBR4040CT-MBR40200CT
Features:

- Low power loss. high efficiency.
High surge capacity
- For use in low voltage, high frequency inverters, free wheeling, and polarity protection applications.
- Metal silicon junction, majority carrier conduction.
- High current Capability. low forward voltage drop.
- Guard ring for over voltage protection.

TO-220

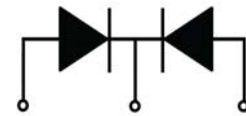
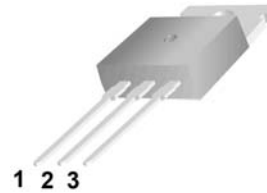

1.Anode 2.Cathode 3. Anode

Absolute Maximum Ratings (Ta=25°C unless otherwise noted)

Parameter	Symbol	MBR 4040 CT	MBR 4045 CT	MBR 4050 CT	MBR 4060 CT	MBR 4080 CT	MBR 4090 CT	MBR 40100 CT	MBR 40150 CT	MBR 40200 CT	Unit
Maximum Recurrent Peak Reverse Voltage	V_{RRM}	40	45	50	60	80	90	100	150	200	V
Maximum RMS Voltage	V_{RMS}	28	31.5	35	42	56	63	70	105	140	
Maximum DC Blocking Voltage	$V_{R(DC)}$	40	45	50	60	80	90	100	150	200	
Maximum Average Forward Current	$I_{F(AV)}$	40									A
Peak Forward Surge Current:8.3ms single half sine-wave superimposed on rated load (JEDEC method)	I_{FSM}	350									
Maximum Forward Voltage at 20A per leg	V_F	0.65		0.72			0.85		0.92		V
Maximum DC Reverse Current at Rated DC Blocking Voltage	$T_j=25^\circ\text{C}$	0.1							0.05		mA
	$T_j=125^\circ\text{C}$	20									
Maximum Operating Junction Temperature	T_j	150				175					°C
Storage Temperature	T_{stg}	-55~+150				-65~+175					
Typical Thermal Resistance	$R_{\theta JC}$	1.3									°C/W

Typical Characteristics

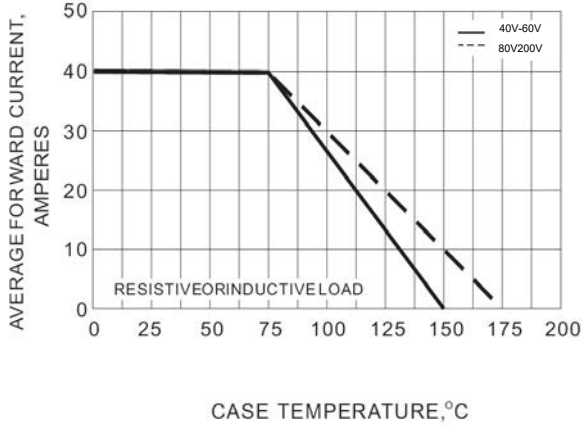

Fig.1 FORWARD CURRENT DERATING CURVE

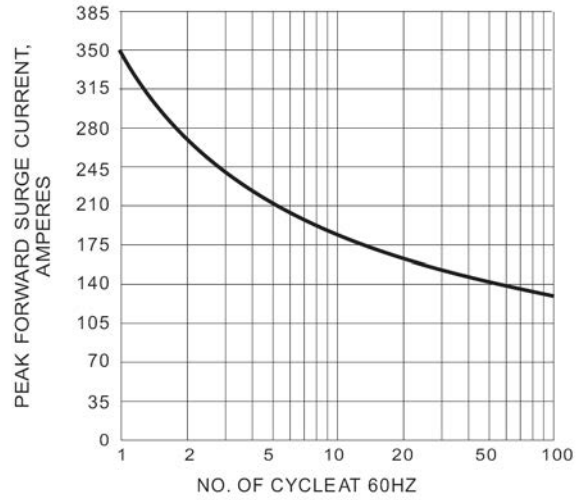

Fig.2 MAXIMUM NON-REPETITIVE SURGE CURRENT

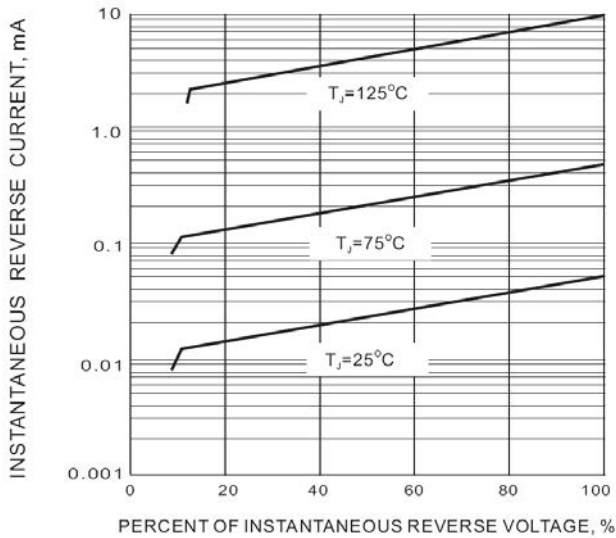

Fig 3. TYPICAL REVERSE CHARACTERISTIC

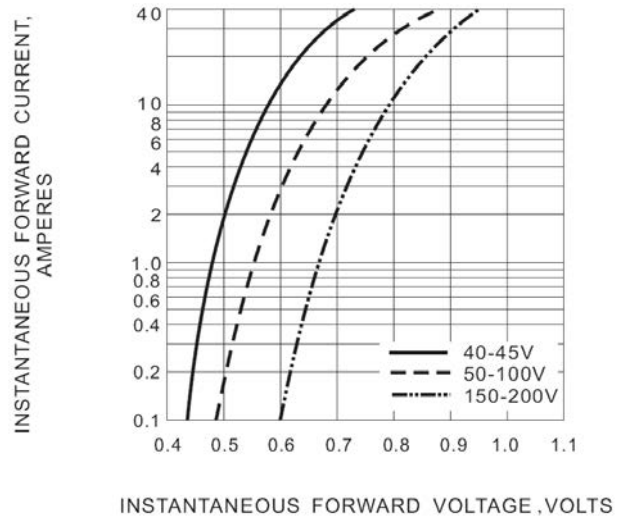
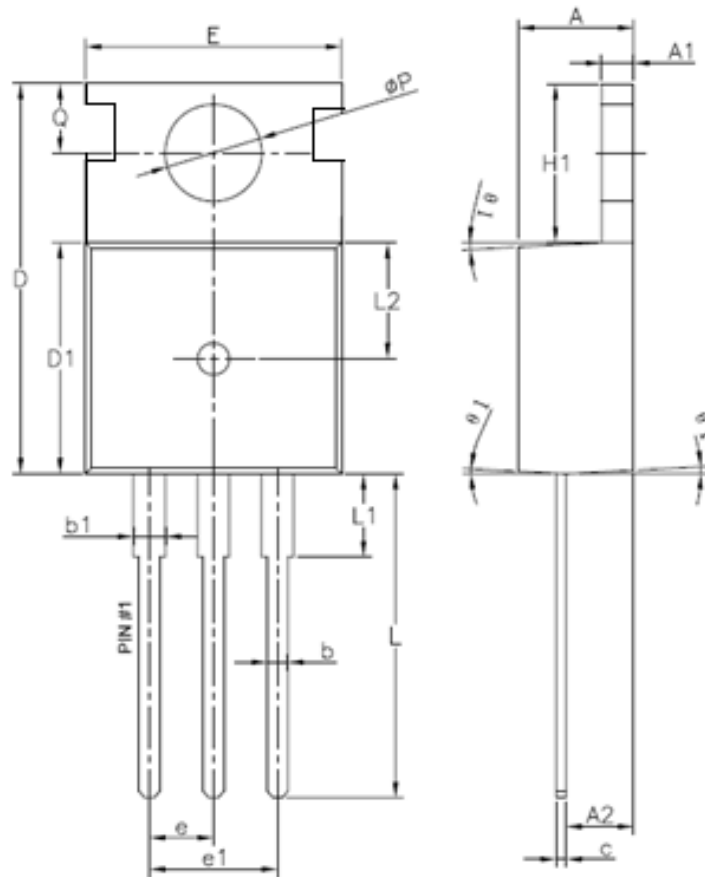

Fig 4. TYPICAL INSTANTANEOUS FORWARD CHARACTERISTIC

Package Dimension
TO-220

Unit: mm

Symbol	Min	Normal	Max	Symbol	Min	Normal	Max
A	4.4	4.5	4.6	e		2.54	
A1	1.27	1.3	1.33	e1		5.08	
A2	2.3	2.4	2.5	H1	6.3	6.5	6.7
b	0.7	/	0.9	L	13.0	13.38	13.5
b1	1.25	/	1.42	L1	/	/	3.5
c	0.45	0.5	0.6	L2		4.6	
D	15.3	15.7	16.1	ΦP	3.55	3.6	3.65
D1	9.1	9.2	9.3	Q	2.73	/	2.87
E	9.7	9.9	10.2	θ_1 (°)	1	3	5